

HP® LASERJET P1102

CARTRIDGE REMANUFACTURING INSTRUCTIONS



HP LASERJET P1102 TONER CARTRIDGE

REMANUFACTURING THE HP LASERJET P1102 SERIES TONER CARTRIDGE CE285A

By Mike Josiah and the Technical Staff at UniNet

In May 2010, Hewlett Packard released the LaserJet P1102 printer. The HP P1102 series of laser printers are based on a 19ppm, 400 x 600dpi Canon engine. These cartridges use a chip that controls the toner low functions. The CE285A is rated for 1,600 pages.

The printer itself has a very small foot print. It's a nice small office/home machine. The memory is fixed and not expandable at 8MB. The recommended monthly volume is from 250-1,500 pages/month. These machines also have a new feature called "Smart install" in which the printer driver is built into the printer, so no drivers need to be installed. Just plug in the USB or Ethernet cable and you can start printing!

The printer when new comes with a starter cartridge that is rated for 700 pages at 5% coverage, so your customers will be coming to you fairly quickly!

There are currently four printers based on this engine. The P1102, P1102W, M1130 and the M1212NF.

The new cartridge is a modified version of the older P1505 cartridge. In fact, many parts for the P1505 work in this new cartridge as well.

Cartridge troubleshooting as well as running test pages, cleaning pages, and some simple printer troubleshooting will be covered at the end of this article.

The theory for these cartridges is a little different from past versions so we have covered it here. You don't have to know the theory to remanufacture cartridges, but it sure helps if you have a problem. Troubleshooting time can be dramatically reduced.

CARTRIDGE THEORY

This figure gives a nice block diagram of the printing process:

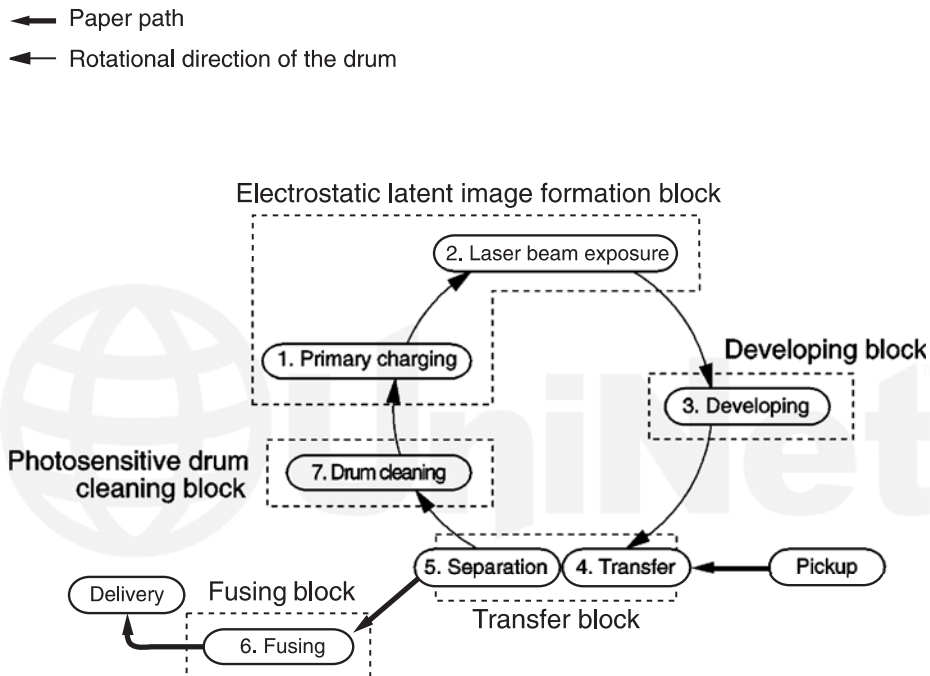

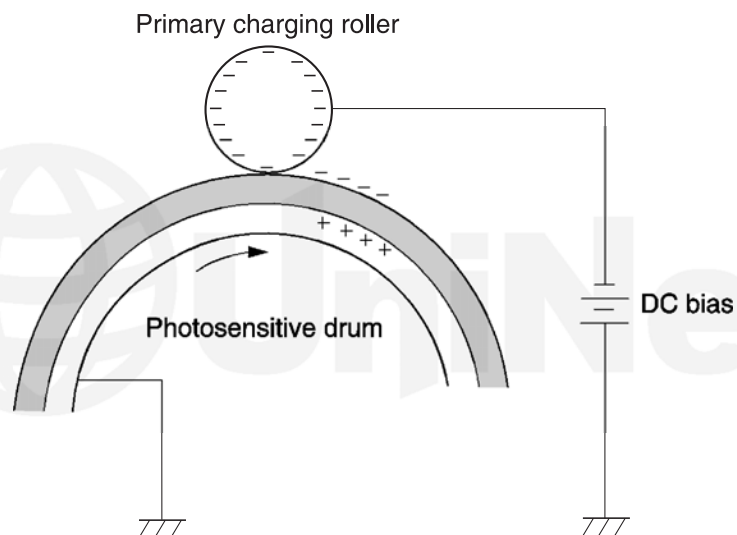

The image formation process consists of a series of steps: in the **first step**, the Primary Charge Roller (PCR) places a uniform negative DC Bias voltage on the OPC drum surface. The amount of the negative DC Bias placed on the drum is controlled by the printer intensity setting. This process is part of the Latent Image Formation Block.

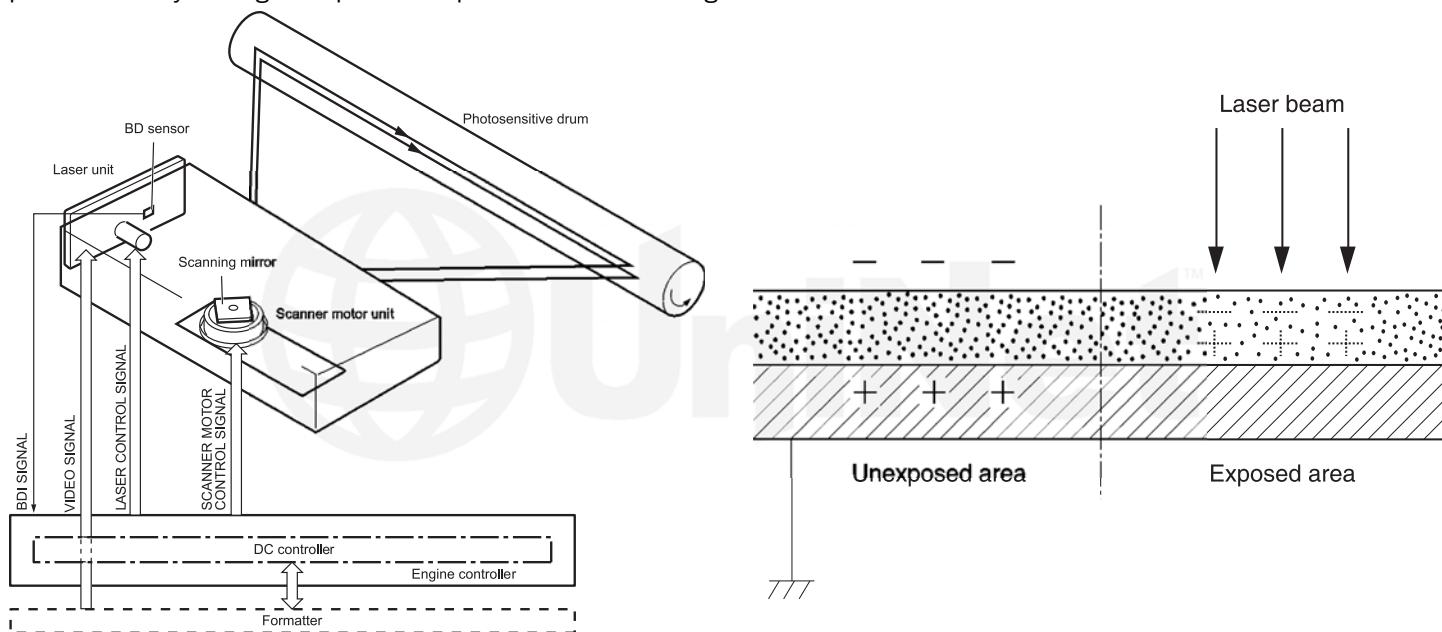

In the **second step**, the laser beam is fired onto a rotating mirror (called the scanner). As the mirror rotates, the beam reflects into a set of focusing lens. The beam then strikes the OPC surface, which neutralizes the negative charge on the drum and leaves a latent electrostatic image on the drum. The laser unit actually fires two beams. The service manual does not mention the second laser beam at all, but at this point we are not sure if the second laser actually helps erase any residual charges on the drum or helps speed up the printing process. We are leaning towards the second laser helping to erase any residual images as other recent Canon based engines also use the dual laser for this.

The **third step** (Developing Block) is where the toner image is developed on the drum by the developing section, (or supply chamber), which contains the toner particles. The toner is held to the magnetic roller sleeve by the stationary magnet inside the sleeve, and a DC bias voltage supplied by the high voltage power supply. This DC bias voltage is controlled by the printer density setting, and causes either more or less toner to be attracted to the drum. This in turn will either increase or decrease the print density. Both the primary charge and magnetic roller DC Bias voltages are controlled by the printer density setting. The amount of toner on the magnetic roller sleeve is also controlled by the rubber doctor blade, which uses pressure to keep the amount of toner on the magnetic roller sleeve constant. This blade also causes a static charge to build up on the toner, which helps keep the coating of toner even, and allows easy transfer to the OPC drum.

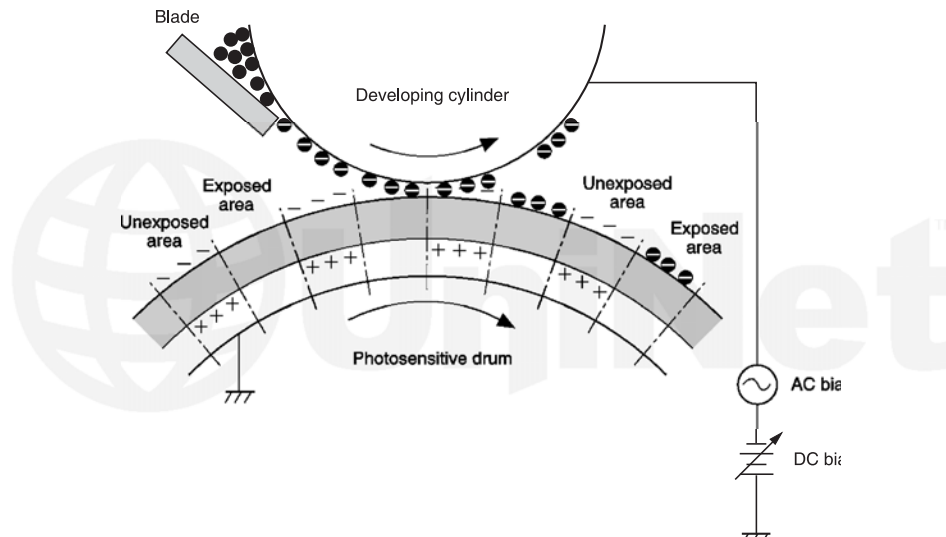

At the same time an AC signal is also placed on the magnetic roller sleeve. This signal decreases the attraction of the toner to the magnetic roller sleeve, and increases the repelling action of toner against the areas of the drum that was not exposed to the laser beam. This AC potential improves the density and contrast of the toner on the printed page. As the laser-exposed areas of the OPC drum approach the magnetic roller, the toner particles are attracted to the drums surface due to the opposite voltage potentials of the toner, and laser-exposed surface of the OPC drum.

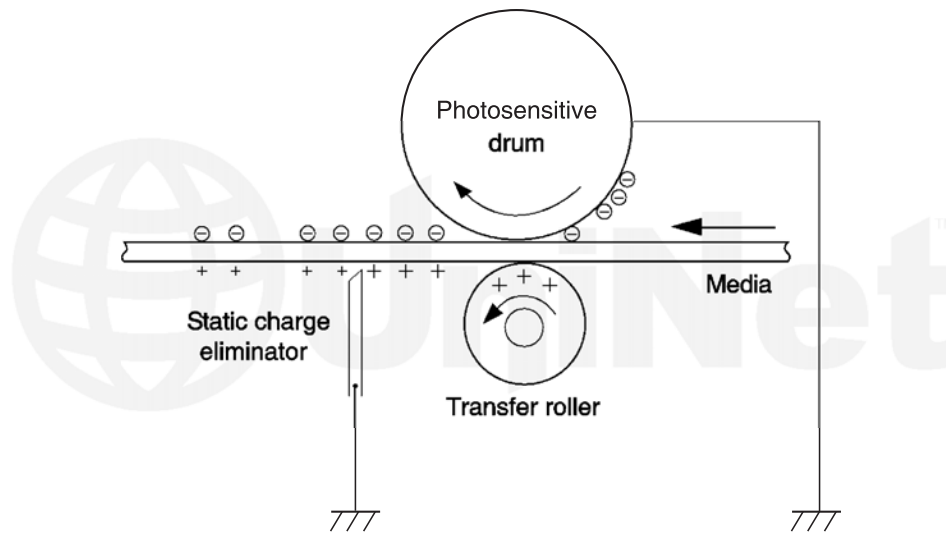

In the **fourth step** (Transfer Block) the toner image is then transferred to the paper as it passes below the drum by the transfer charge roller, which places a positive charge on the back of the paper. This positive charge causes the negatively charged toner on the drum's surface to be attracted to the page. The small diameter of the drum, combined with the stiffness of the paper causes the paper to peel away from the drum.

In the **fifth step** (also part of the transfer block) the paper separates from the drum. The static charge eliminator weakens the attractive forces between the negatively charged drum surface, and the positively charged paper. This prevents toner dropouts onto the paper at low temperatures and humidity, and also prevents paper from wrapping around the drum.

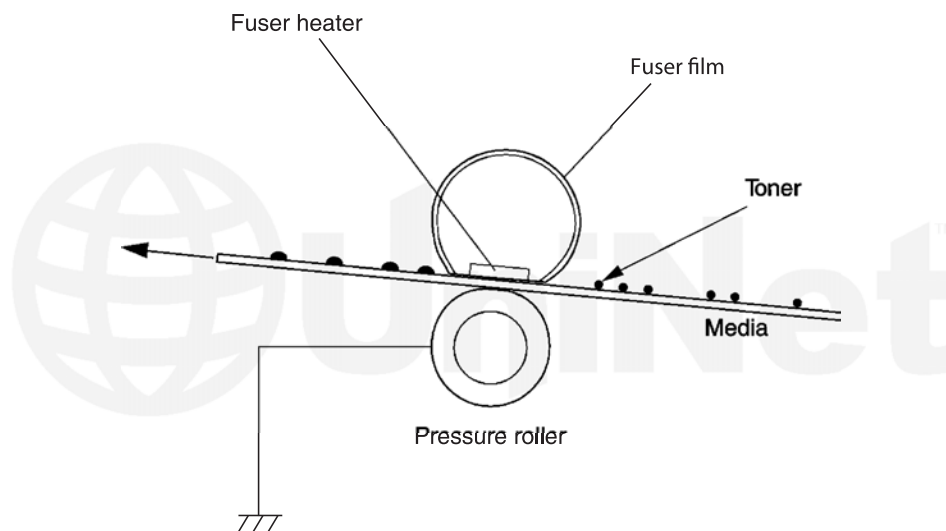

In the **sixth step**, the image is fused on to the paper by the fuser-assembly, which is comprised of the upper fixing film assembly and the lower fuser roller. The paper passes between a heated upper fixing film assembly and a soft lower rubber roller. The upper heated element then melts the toner into the paper. The fixing film assembly consists of a Teflon sleeve with a ceramic heating element inside. These fusers are a bit different in that they have a brush, which has a DC Bias charge on it to help keep the film clean.

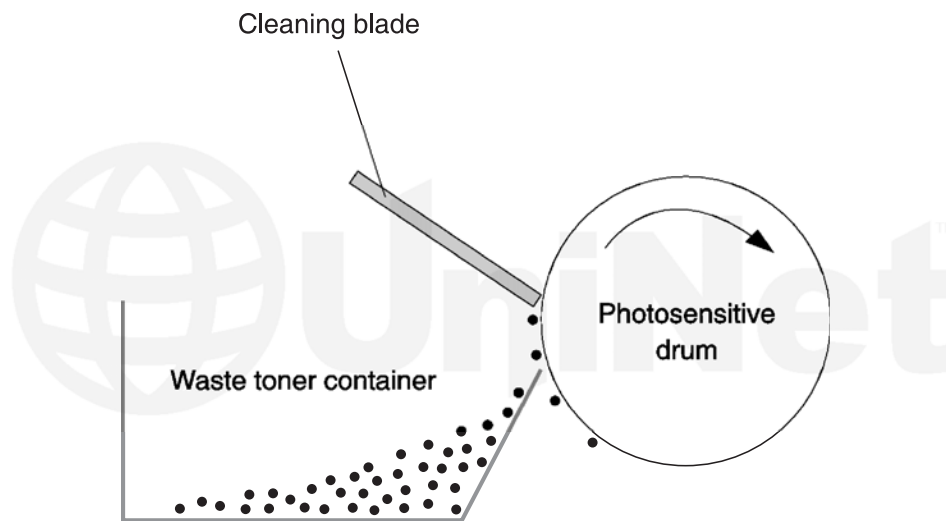

In the **seventh step** the OPC drum is cleaned. On average, approximately 95% of the toner is transferred to the paper during the print cycle. As the drum rotates during printing, the remaining 5% of the toner is cleaned off the drum by the wiper blade. It is then guided into the waste chamber by the recovery blade and stored in the waste chamber.

The **eighth step** is where the residual charge is eliminated. Both the PCR and the laser unit are used for this. The primary charge roller places an AC voltage across the drum surface and the laser unit's second beam erases and residual charges left on the drum. This drum charge elimination is only turned on during the last rotation period of the drum.

The following figures show the differences from another newly released cartridge for the HP P1606 series of printers: the CE278A cartridge. Neither of these cartridges is compatible with the P1006 (CB435A) or P1505 (CB436A). They are all physically different.

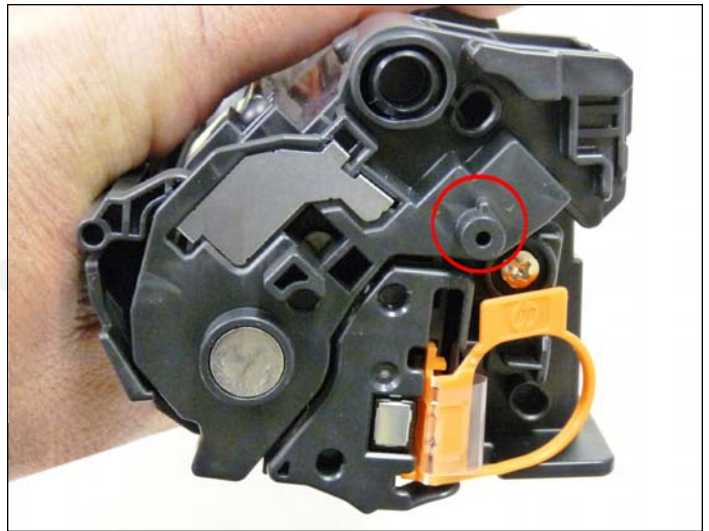
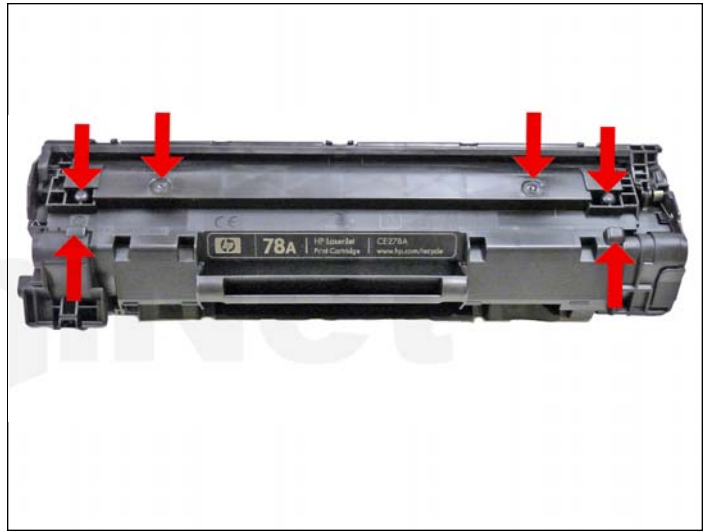
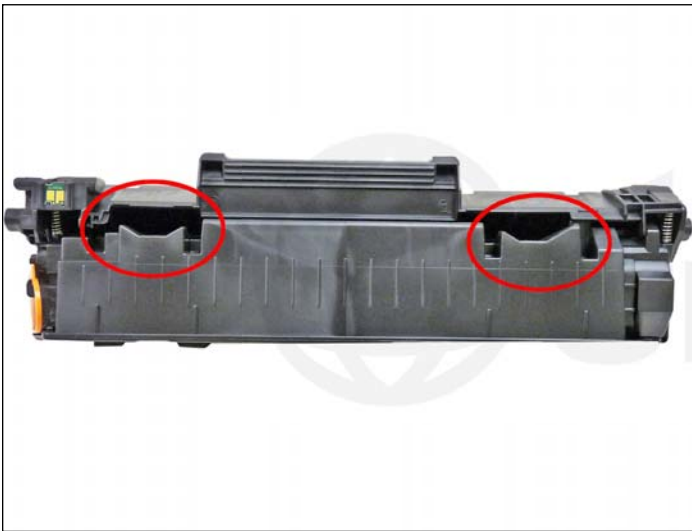

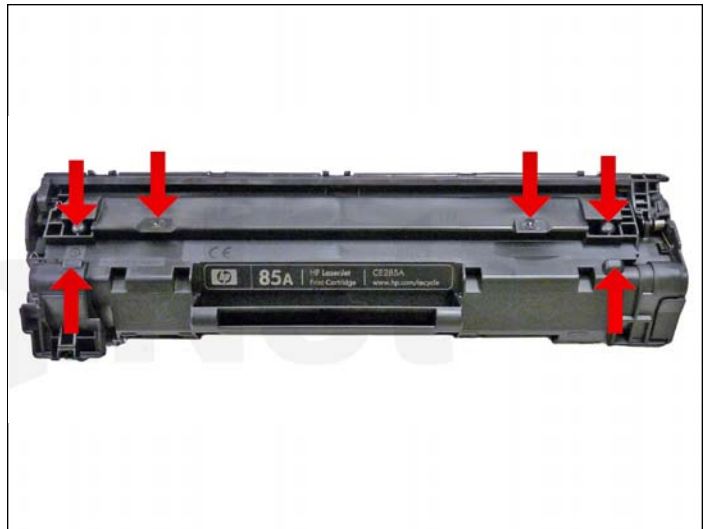

SUPPLIES REQUIRED

1. HP P1102 toner
2. New drum
3. Replacement chip (dedicated)
4. Wiper blade
5. Doctor blade
6. Magnetic roller
7. Sealing strip
9. Cotton swabs
10. Isopropyl alcohol
11. Drum padding powder
12. Conductive grease

TOOLS REQUIRED

1. Phillips head screwdriver
2. Small common screwdriver
3. Needle nose pliers
4. Jewelers screwdriver set

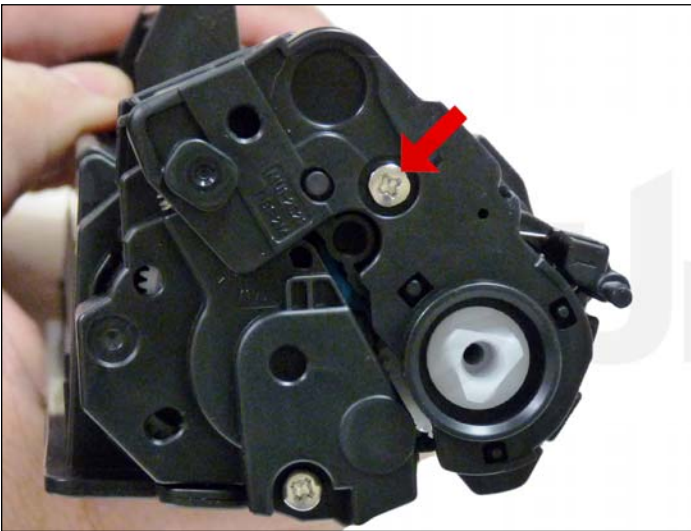

1. With the handle facing you, remove the right side screw and end cap from the cartridge.

Be careful of the drum cover spring! Remove it with the end cap.

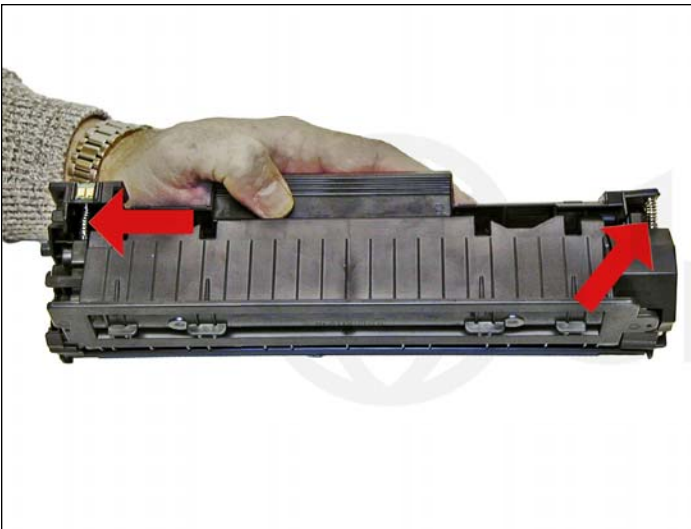

2. With the pair of needle nose pliers, release both the hopper tension springs.

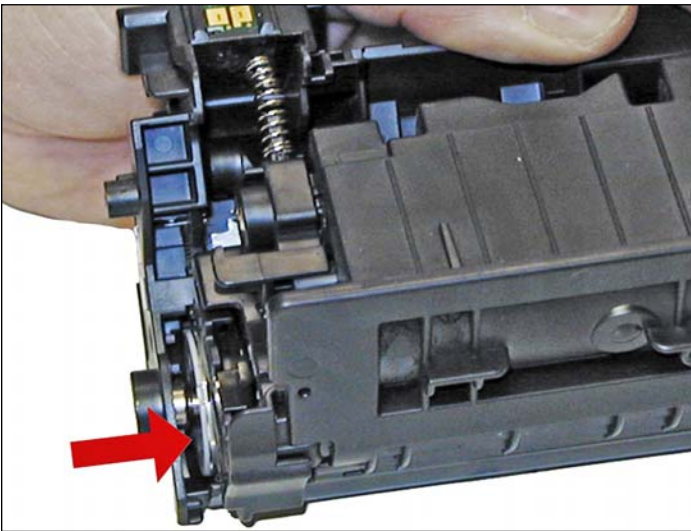

3. Slide the waste/drum section over to the left side.

Separate the two halves.

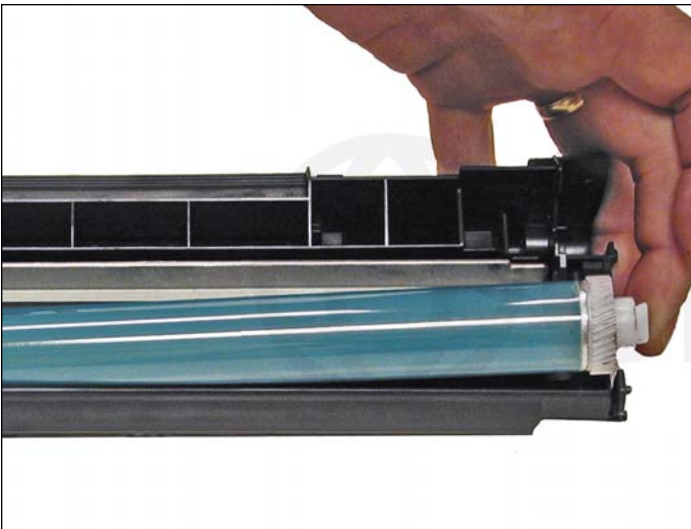

4. On the waste/drum section, lift the drum up from the gear side. Twist and remove from the hopper.

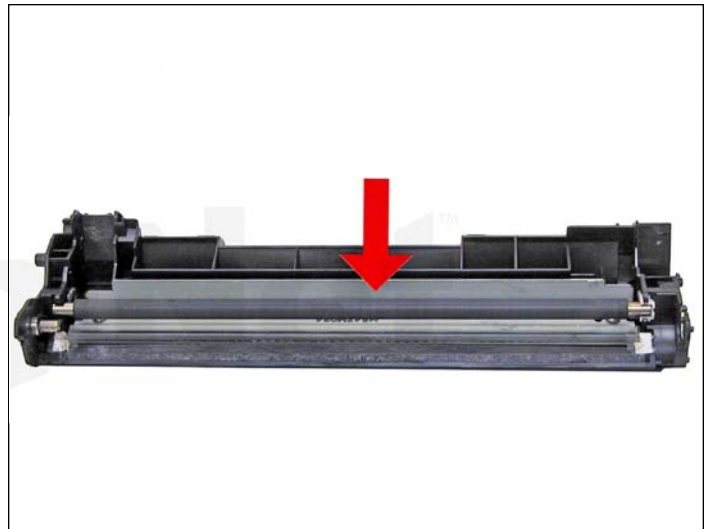

5. Remove the PCR and clean with your standard PCR cleaner.

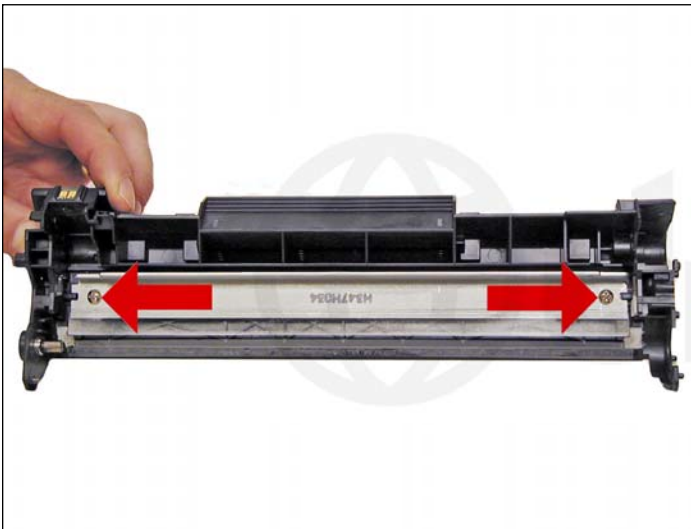

6. Remove the two screws and the wiper blade.

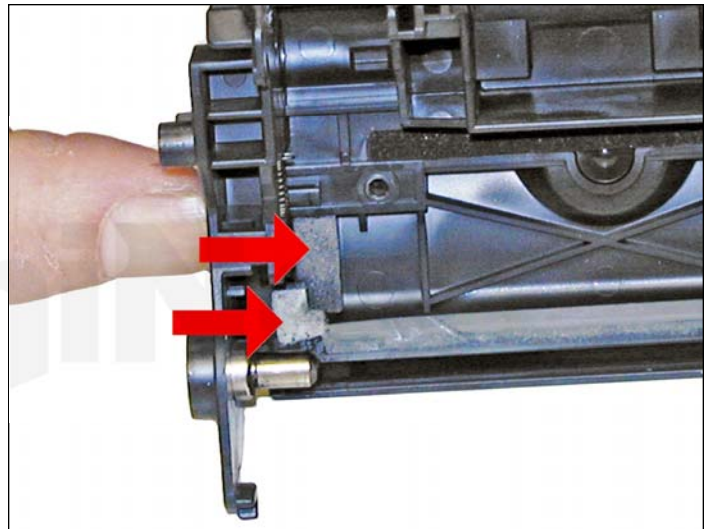
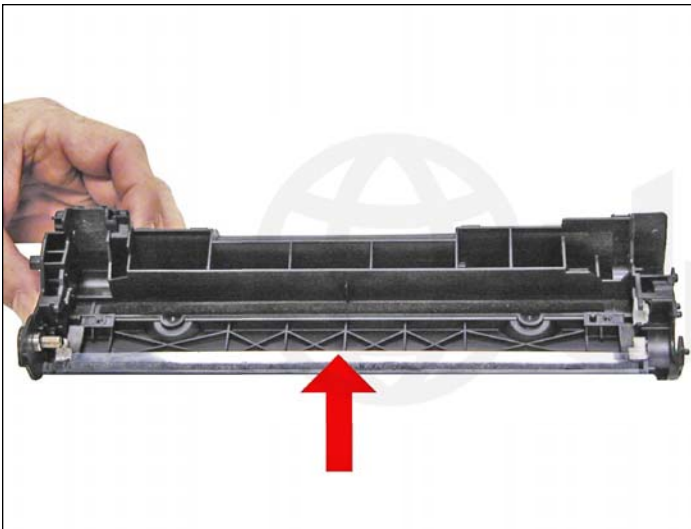

7. Clean out all the waste toner from the hopper. Be careful not to damage the recovery blade located next to the wiper blade.

If this blade is bent in any way, the cartridge will leak. Make sure the wiper blade foam seals are clean.

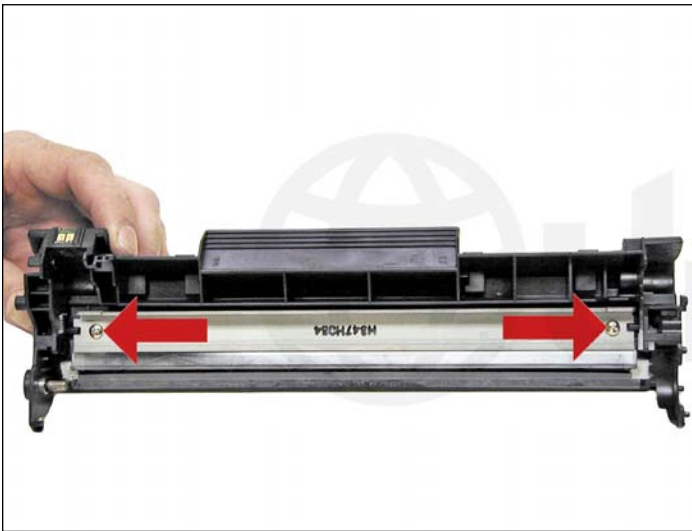

8. Coat the new/cleaned wiper blade with your preferred lubricant. Install the wiper blade and two screws.

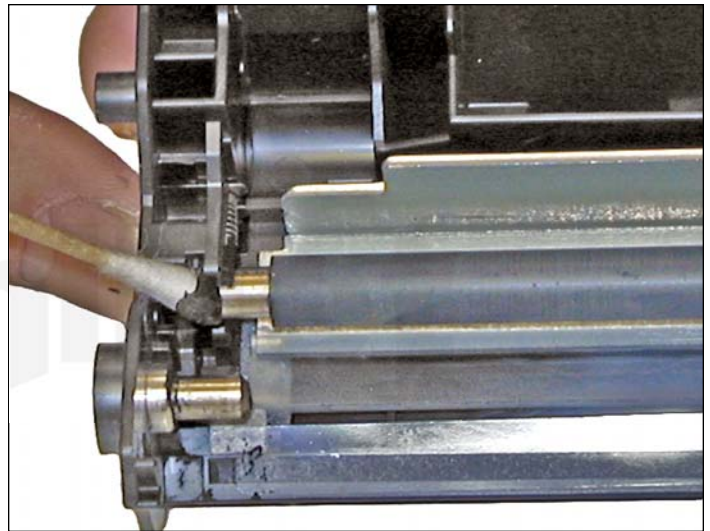

9. Install the cleaned PCR. Place a small amount of conductive grease on to the black holder side of the shaft. Just a small amount of grease is more than sufficient.

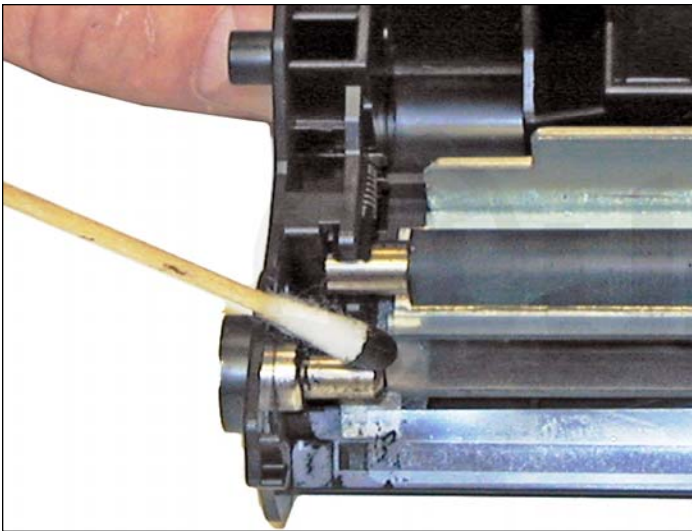

10. Place another small amount of conductive grease on to the metal drum axle.



11. Install the new/cleaned drum hub side first.

Place the waste/drum section aside.

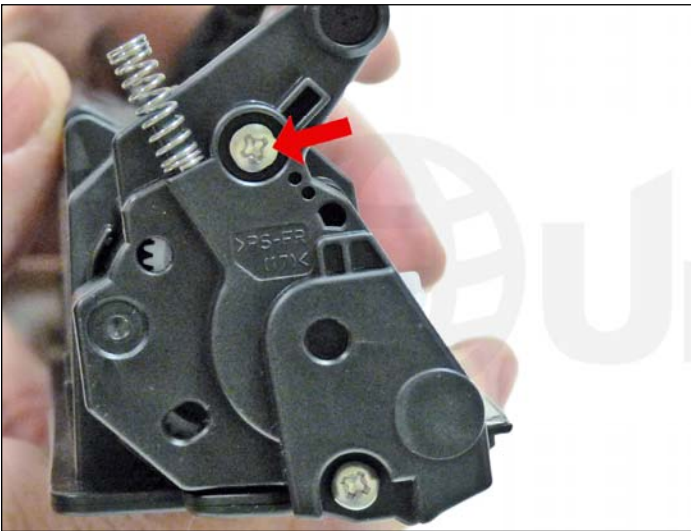

12. On the toner supply chamber right side, remove the two screws and end cap.

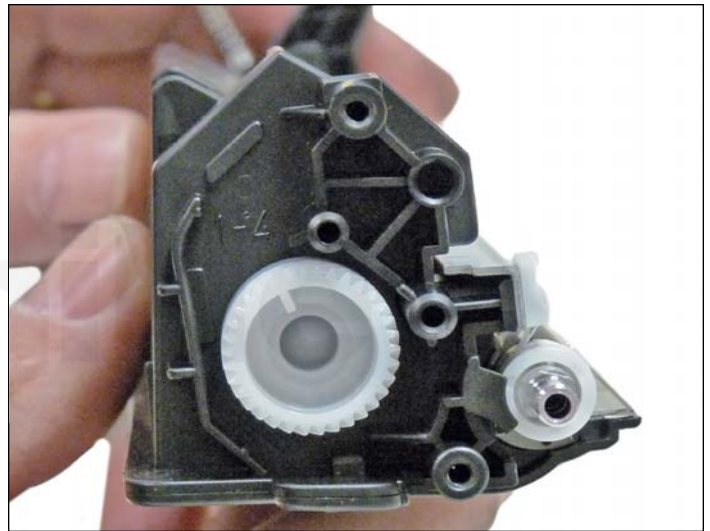
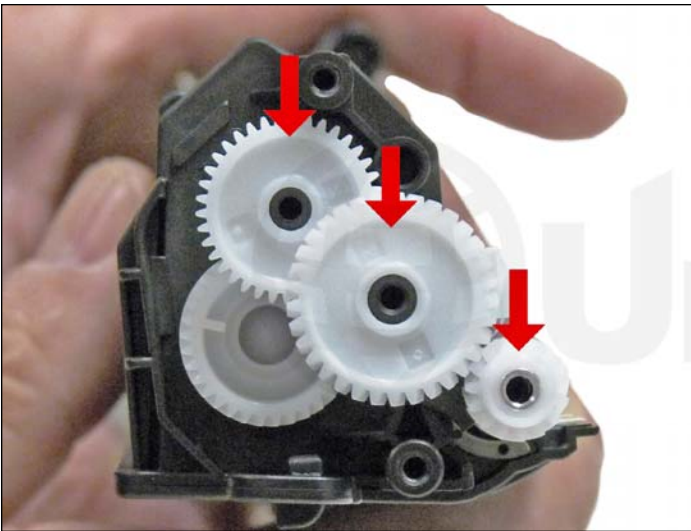

13. Remove the gears from the hopper as shown.

Leave the large auger gear in place.



14. Remove the single screw and end from the opposite side.

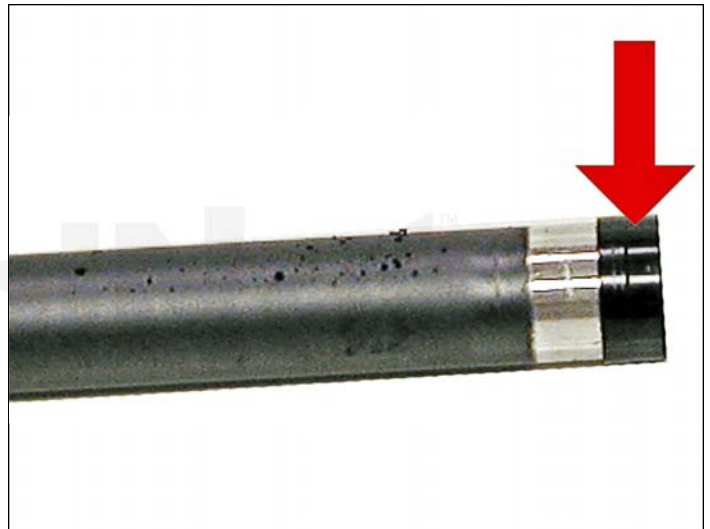

15. Remove the magnetic roller assembly.

Be careful of the bushings! They are very fragile.



16. Remove the doctor blade and two screws.

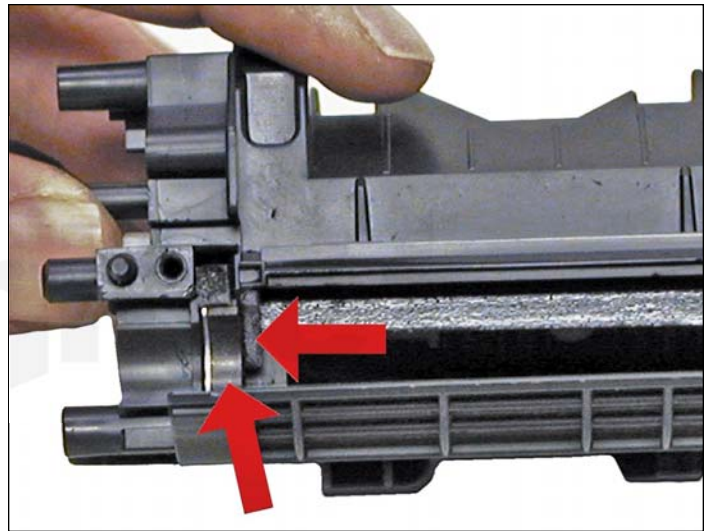

17. Clean out all the remaining toner from the hopper. Make sure the magnetic roller seals and the doctor blade seals are all clean.



18. Fill the hopper with P1102 toner.

UniNet™

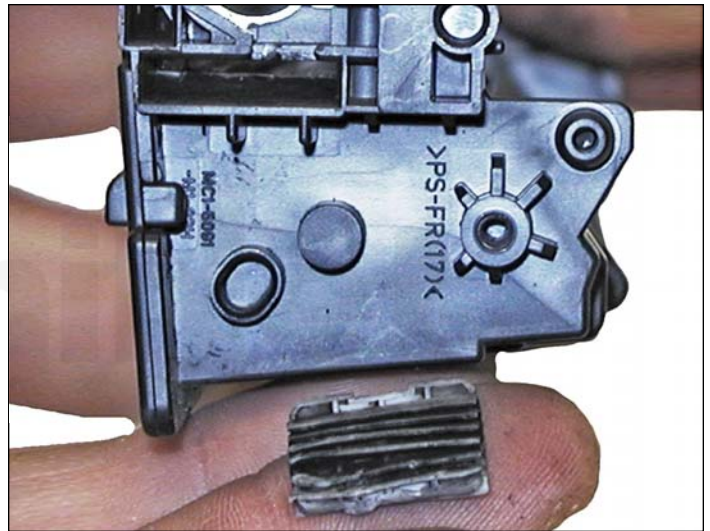
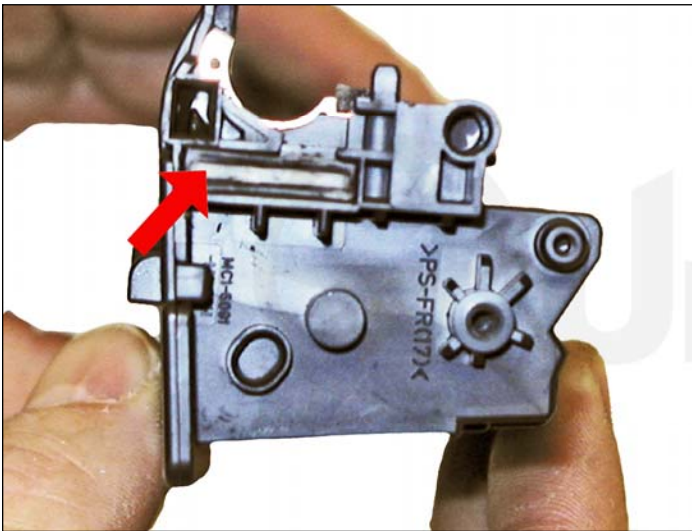

19. When a seal becomes available, remove the seal port plug, and install the seal.

Bring the tail out through the seal porthole. Install the plug.

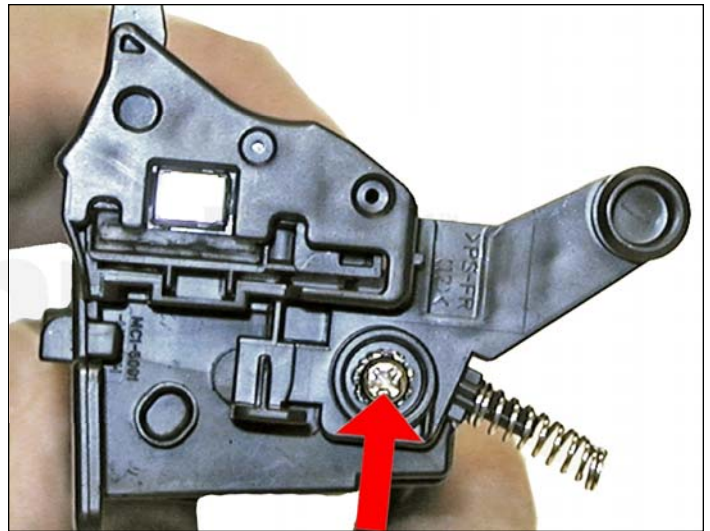
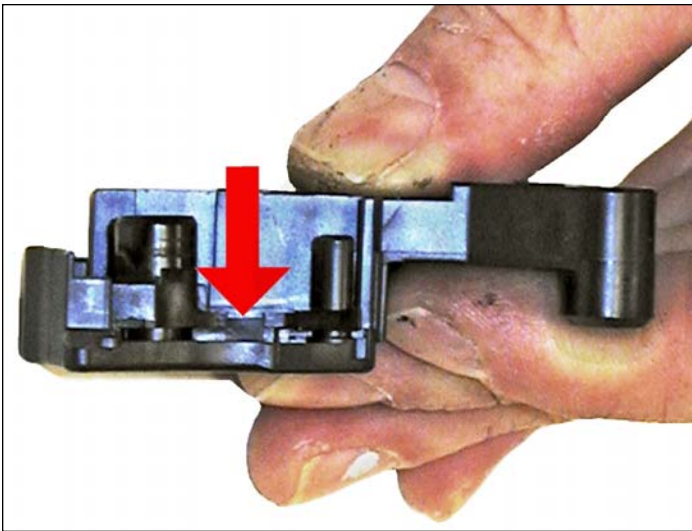

20. Install the left side end cap and screw.

Make sure the small contact piece is installed correctly on the end cap.



21. Install the doctor blade and two screws.

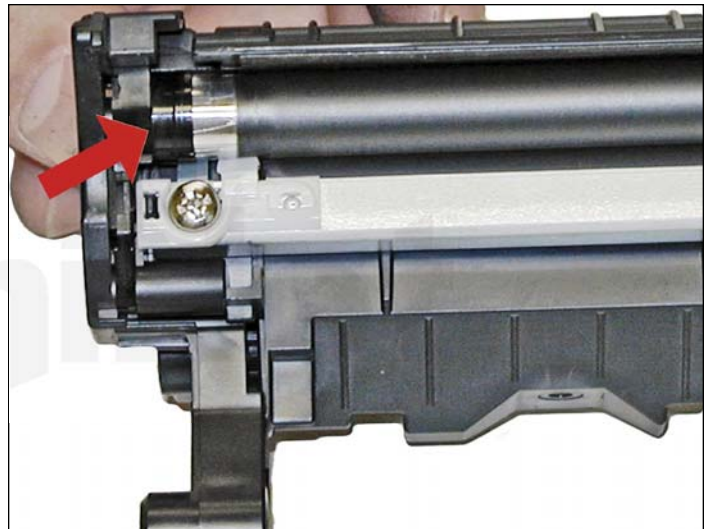

22. Install the magnetic roller black bushing side first.

Turn the roller until the keyed end locks in place.

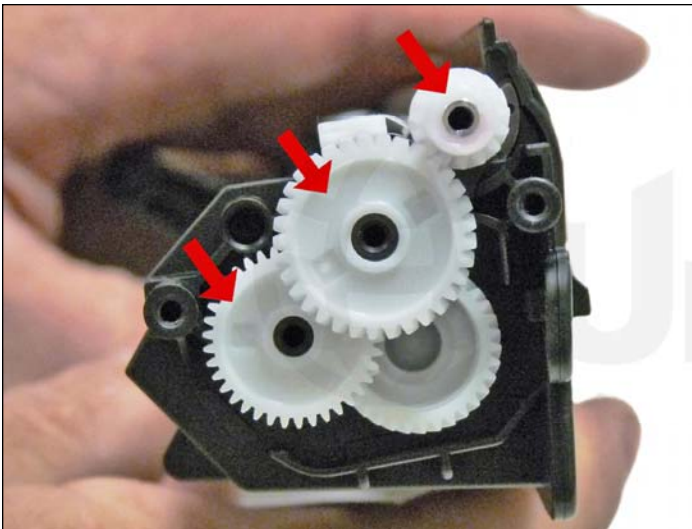

23. Install the gears as shown.

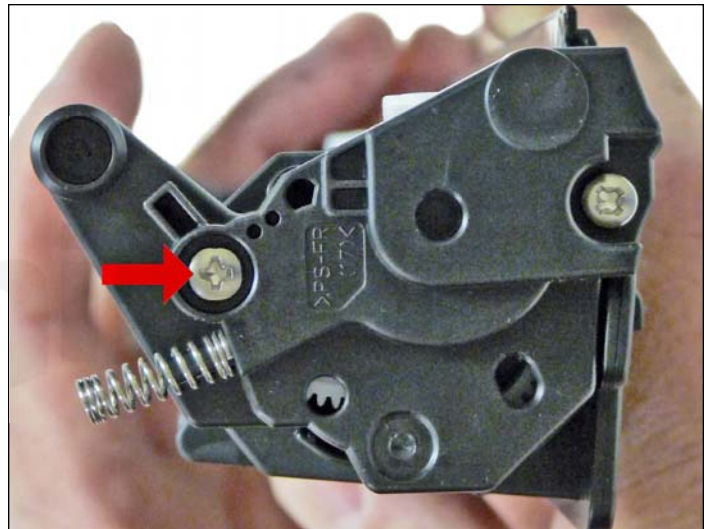

24. Install the end cap and screws.

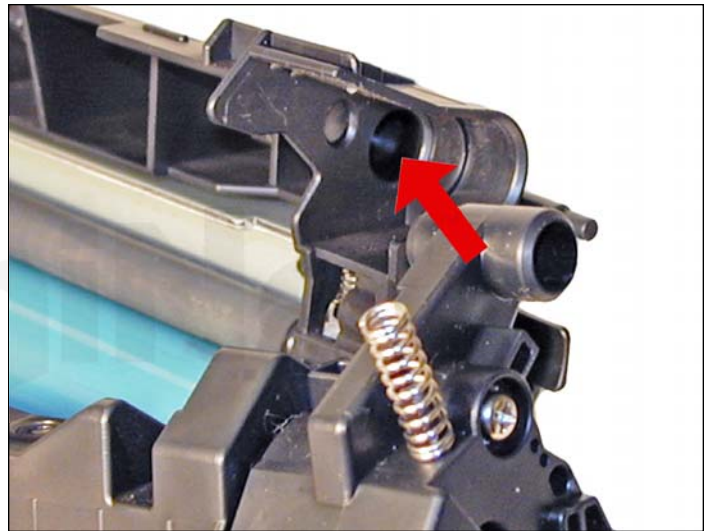
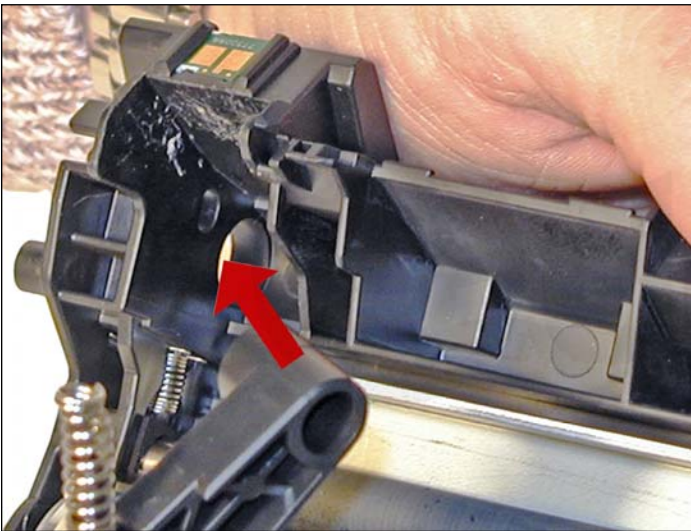

25. Place the drum/waste hopper into the toner hopper.

Slide it over so the round hinge pins fit into their respective holes.

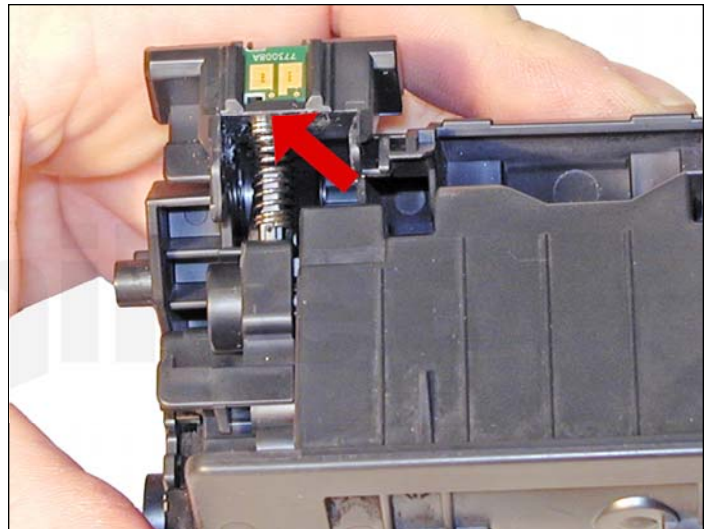
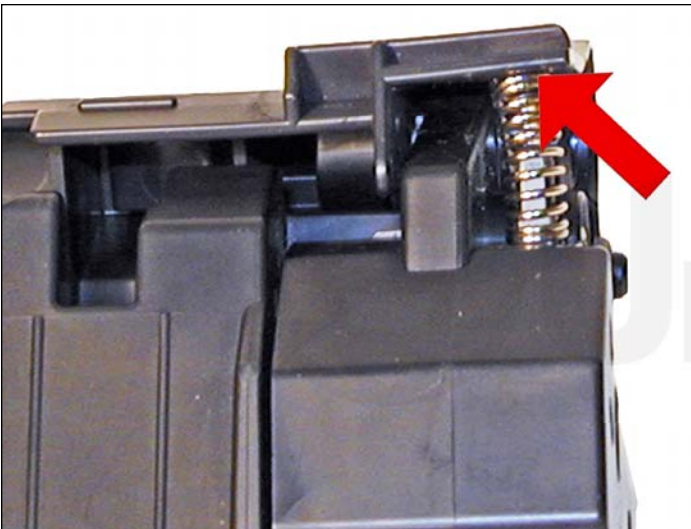

26. Set the hopper tension springs back in place.

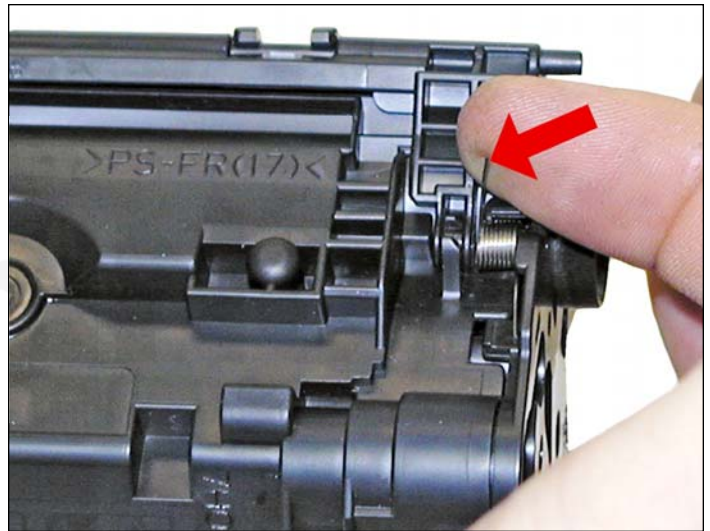
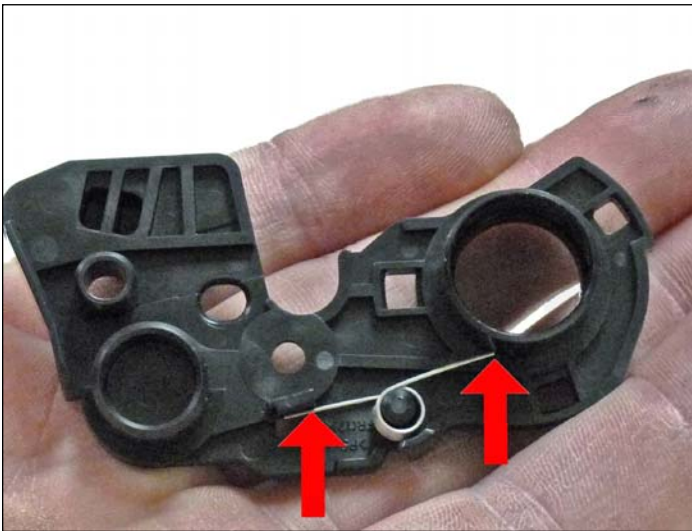

27. With the drum cover spring as shown on the end cap, install the end cap.

Lift up the tail of the spring to fit onto the hopper.

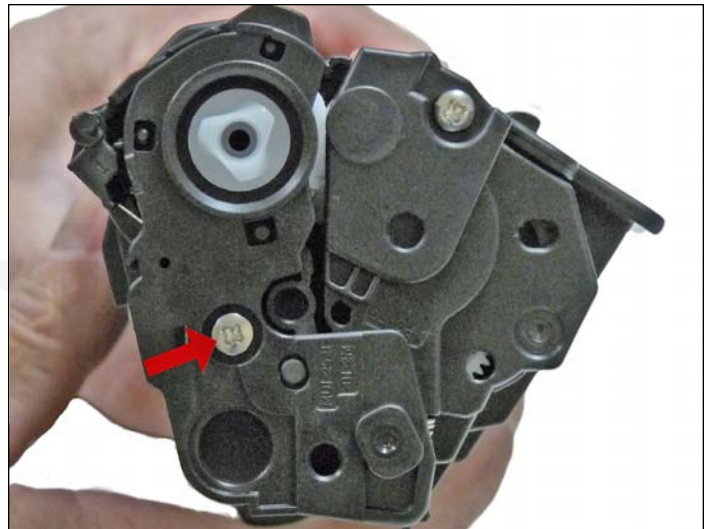
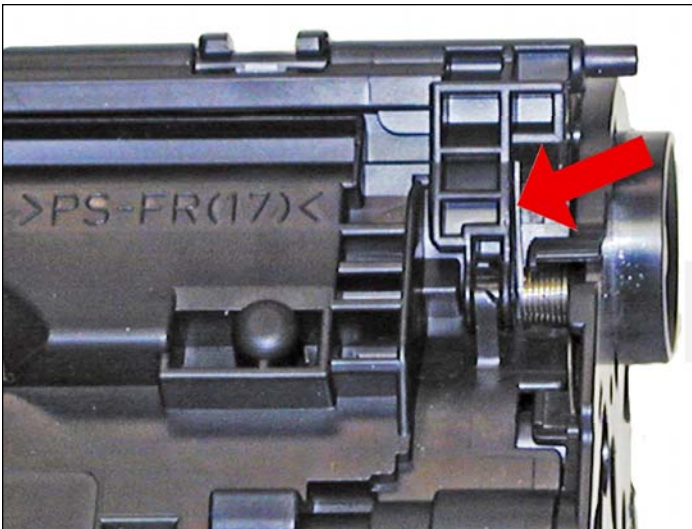

28. Lift up the drum cover spring tail to fit as shown on the drum cover.

Install the screw into the cover.

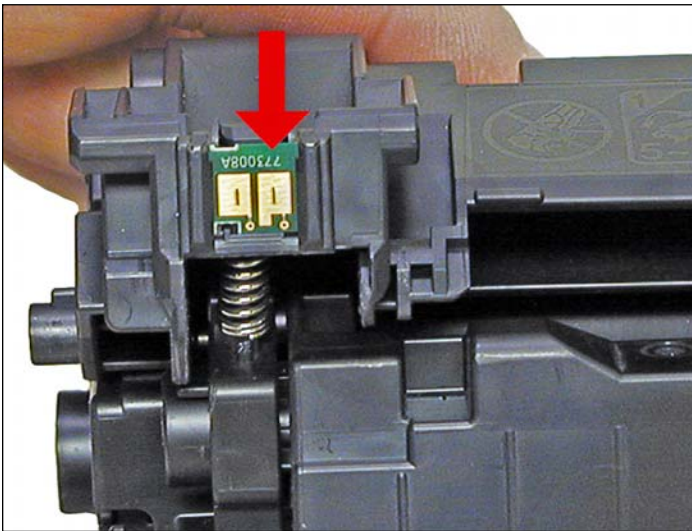

29. Replace the chip.

REPETITIVE DEFECT CHART

OPC Drum:	75mm
Upper Fuser Film:	57mm
Lower Pressure Roller:	56mm
Transfer Roller:	39mm
Magnetic Roller:	34mm
PCR:	27mm

RUNNING TEST PAGES

Test pages must be run from the P1102 menu. Access the Printer Preferences menu, then Services, and Information pages. There are three test pages that can be selected. The Demo, Config, and Supply Status Page.

RUNNING THE CLEANING PAGE

The cleaning page for these machines can only be run from the Printer menu. HP recommends that for best results, a transparency be used. If a transparency is not available, use copier grade paper with a smooth surface.

1. To run this page, access the printer preferences.
2. Click on DEVICE SETTINGS.
3. In the Cleaning Page area, press START.
4. The cleaning cycle takes up to two full minutes. The page will start and stop. Do not turn the printer off until the cleaning page has finished printing.